



IS YOUR TONOMETER ACCURATE?

Your guide to checking tonometer calibration



Look closer. See further.

THE IMPORTANCE OF PERFECT CALIBRATION

Reliable results & reduced equipment downtime

With eye clinics becoming increasingly busy it is vital that all tonometry equipment is maintained to the highest possible standard. Patient safety is critical, so it is imperative that routine checks are completed regularly. This ensures that faults are quickly identified and that all measurements are accurate. Haag-Streit guidelines advise that the calibration of your tonometer should be checked at least once every month to ensure it performs in accordance with standards and specifications.

This leaflet outlines the recommended procedures for checking tonometer calibration. It gives you advice on what to do if you find your tonometer is out of calibration during checks.

In this leaflet you will find checking procedures for the following tonometers; AT 900M/Q, AT 900 C/M and AT 900 BQ.

Check at measuring drum setting 0

Check position -0.05

Turn the zero calibration on the measuring drum downwards by the width of one calibration marking, against the index marker. When the feeler arm is in the free movement zone, it should then move itself against the stop piece in the direction of the examiner.

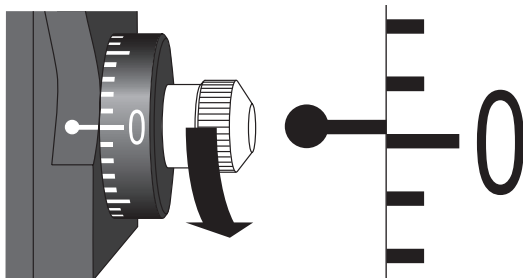

Fig. 1: Check position -0.05

Check position +0.05

Turn the zero calibration on the measuring drum upwards by the width of one calibration marking, against the index marker. When the feeler arm is in the free movement zone, it should then move itself against the stop piece in the direction of the patient.

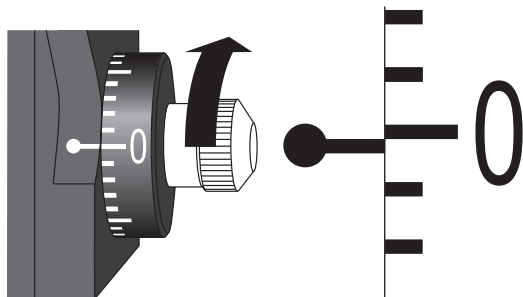

Fig. 2: Check position +0.05

Check at measuring drum setting 2

For this control procedure the check weight is used. Five circles are engraved on the weight bar. The middle one corresponds to drum position 0, the two immediately to the left and right correspond to position 2 and the outer ones to position 6.

One of the marks on the weight corresponding to drum position 2 is set precisely on the index mark of the weight holder. Holder and weight are then fitted over the axis of the tonometer (1) so that the longer part of the weight points towards the examiner (Fig. 3).

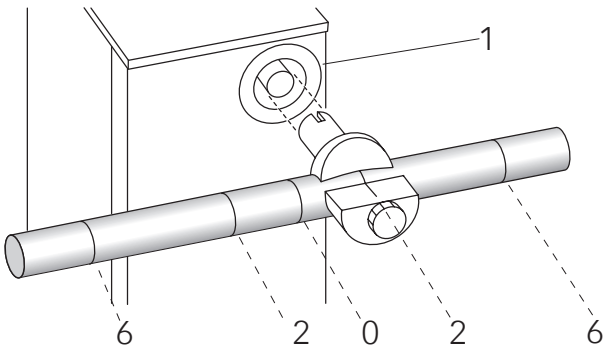

Fig. 3: Check weight



CAUTION

This is the most important check procedure, as the measuring of the ocular pressure in this area is highly significant.

Check at measuring drum setting 2 (cont.)

Check position 1.95

When the measuring drum setting is 1.95, the feeler arm should move from the free movement zone against the stop piece towards the examiner.

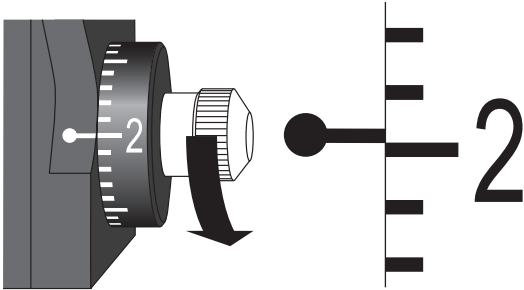

Fig. 4: Check position 1.95

Check position 2.05

When the measuring drum setting is 2.05, the feeler arm should move from the free movement zone against the stop piece in the direction of the patient.

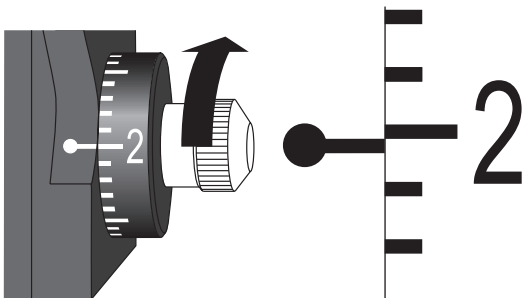

Fig. 5: Check position 2.05

Check at measuring drum setting 6

Turn the weight bar to scale calibration 6, the longer part shows in the direction of the examiner (Fig. 3).

Check position 5.9

The check point is 5.9. The calibration marking 6 on the measuring drum is to be turned 1/2 an interval downwards. The feeler arm should move towards the examiner.

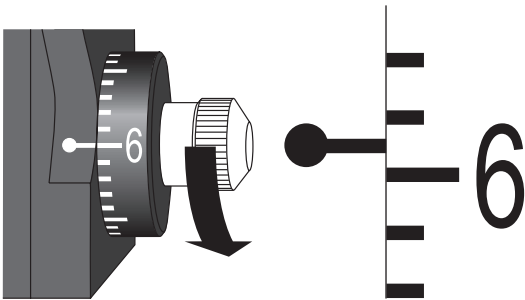

Fig. 6: Check position 5.9

Check position 6.1

The check point is 6.1. The calibration marking 6 on the measuring drum is to be turned 1/2 interval upwards. The feeler arm should move in the direction of the patient.

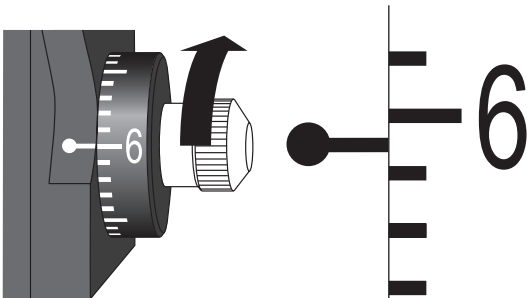

Fig. 7: Check position 6.1

Is your tonometer out of calibration?

The checks in this leaflet should be completed once every month* and a visual inspection should be completed before every use to check for damage. If your tonometer shows errors when you test the calibration, please check the following;

- The measuring prism is properly inserted
- The check weight is precisely adjusted.

Once you have made these checks, repeat the assessment procedure. **Any faulty tonometry equipment should be returned to HS-UK immediately for servicing.**

Why choose HS-UK to service your tonometer?

HS-UK are the only Haag-Streit authorised tonometer service agent in the UK and, thus, the only organisation that uses genuine Haag-Streit tonometer parts and jigs calibrated to Haag-Streit standards.

We automatically replace worn or damaged parts, such as cone arms and internal bearings, meaning your tonometer is fully-repaired and automatically refurbished.

Our dedicated tonometer servicing workshop is fully-equipped with state-of-the-art testing equipment which is calibrated to Haag-Streit standards. We have fully-trained, certified service engineers who will service and repair your tonometer quickly, causing minimal disruption to your clinic.

HS-UK maintain compliance with all applicable regulations and standards for the servicing of ophthalmic diagnostic equipment, including certification to BS EN ISO 13485.



What does my tonometer service include?

For a fixed fee, an HS-UK Service Engineer will dismantle your tonometer and check each of the 67 individual parts for wear and damage. Your tonometer service includes;

- Replacement cone arm
- Replacement bearings
- Tonometer calibration using official Haag-Streit jig
- Genuine Haag-Streit replacements for any parts which are worn or damaged
- Correct adjustment in 0, 2 and 6 positions
- Baseplate and feet check
- Service report listing parts used and batch numbers
- Service certificate

Tonometer repair process

During the repair process, the Haag-Streit Service Engineer will clean the tonometer, ensure movement is smooth, replace any worn parts and check the following;

Bottom shaft

- Shaft spindle, for burrs and damage
- Shaft bearing bolt wheel & pin
- Shaft dial bearing
- Block tension spring
- Star washer & dial

Middle Shaft

- Shaft pin
- Block shaft
- Spindle bar

Top Shaft

- Spindle & pin
- Movement of weights

The Engineer will also replace all the bearings and the cone arm on the tonometer and re-grease the spindle. Once reassembled, a calibration certificate will be issued for each tonometer listing the serial number of the tonometer and the serial number of the test jig used for calibration.

Contact us...

For further information, or to book in a tonometer repair, please contact our service team on **(01279) 456314** or, alternatively, **email service.uk@haagstreit.com**.

If your tonometer is not serviceable and you require a new one, please visit **www.haagstreituk.com/goldmanntonometer** for further information, or alternatively, call **01279 456261**.

HAAG-STREIT UK

Unit C, Woodside Industrial Estate
Dunmow Road
Bishop's Stortford
Hertfordshire
CM23 5RG

(01279) 456314

service.uk@haag-streit.com

<https://hs-uk.co/TonometerService>